

MANUAL DE MONTAGEM

ASSEMBLY INSTRUCTION
INSTRUCCIONES DE MONTAJE

LINHA: PRIMA

PRODUTO: ARMÁRIO MÉDIO CHARUTO

PRODUCT
PRODUCTOS

CÓDIGOS





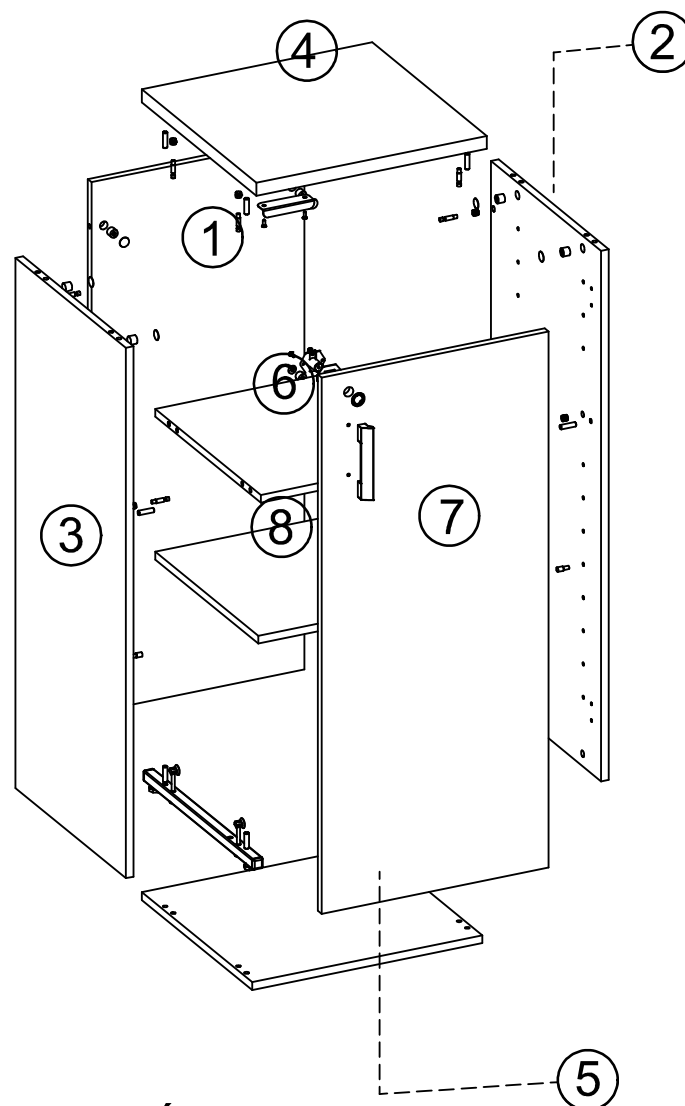
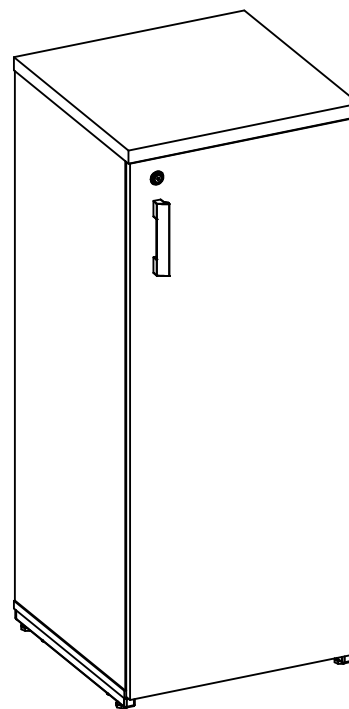



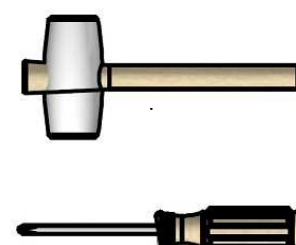







CODES
CÓDIGOS

► 410005004



- 8- PRATELEIRA MÓVEL
- 7- PORTA
- 6- PRATELEIRA FIXA
- 5- BASE
- 4- TAMPO
- 3- LATERAL ESQUERDA
- 2- LATERAL DIREITA
- 1- FUNDO



Q	2	10150038	
O	2	06401007	
N	2	06300205	
M	1	11030015	
L	2	11010010	
K	12	10140002	
J	14	10130014	
I	14	10120003	
H	14	10120001	
G	2	10030246	
F	12	10010546	
E	4	06800101	
D	18	06602015	
C	1	06103012	
B	1	045200048	
A	1	045200046	
Item	Qtd	Cod.	Imagem

PRÉ - MONTAGEM

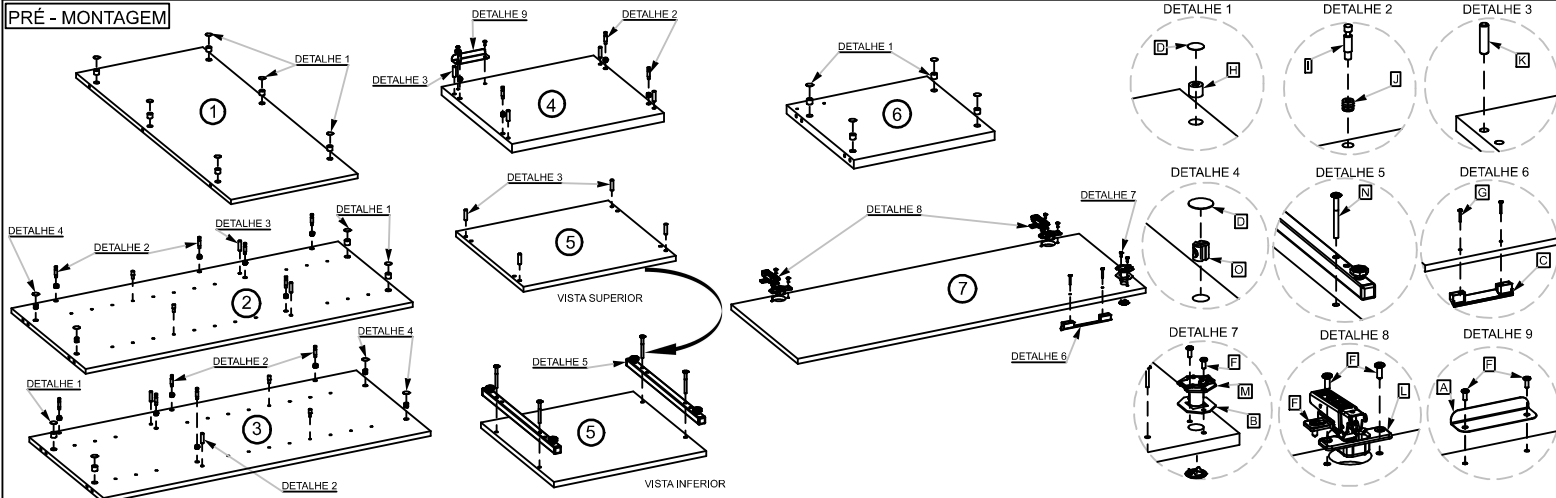

MONTAGEM - PASSO 1

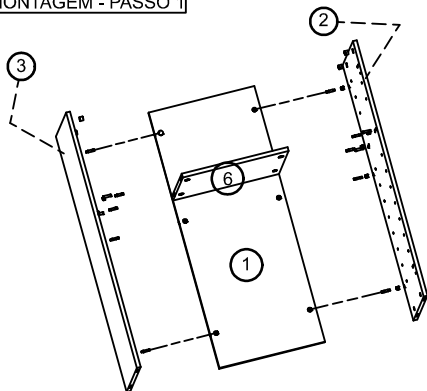

INICIE FIXANDO FUNDO (1), LATERAL DIREITA (2), LATERAL ESQUERDA (3) E PRATELEIRA FIXA (6).

MONTAGEM - PASSO 2

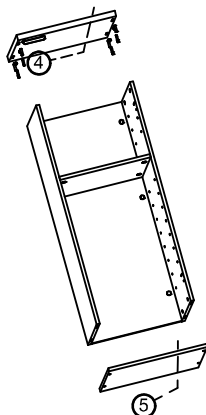

NA SEQUENCIA FIXAR TAMPO (4), BASE E RODAPÉ (5)

MONTAGEM - PASSO 3

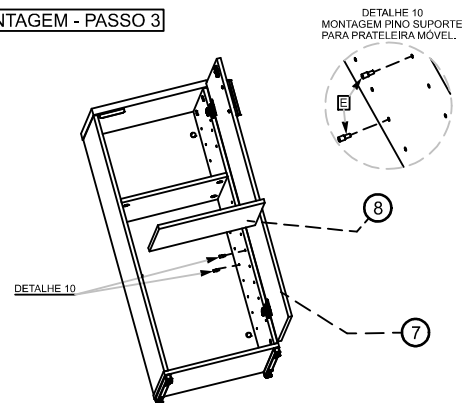

PARA FINALIZAR FIXE A PORTA (7) E APÓS MONTAGEM COMPLETA DO ARMÁRIO INSERIR A PRATELEIRA MÓVEL (8).

SEQUÊNCIA DE MONTAGEM DAS PEÇAS

MOUNTING SEQUENCE
SECUENCIA DE MONTAJE

